

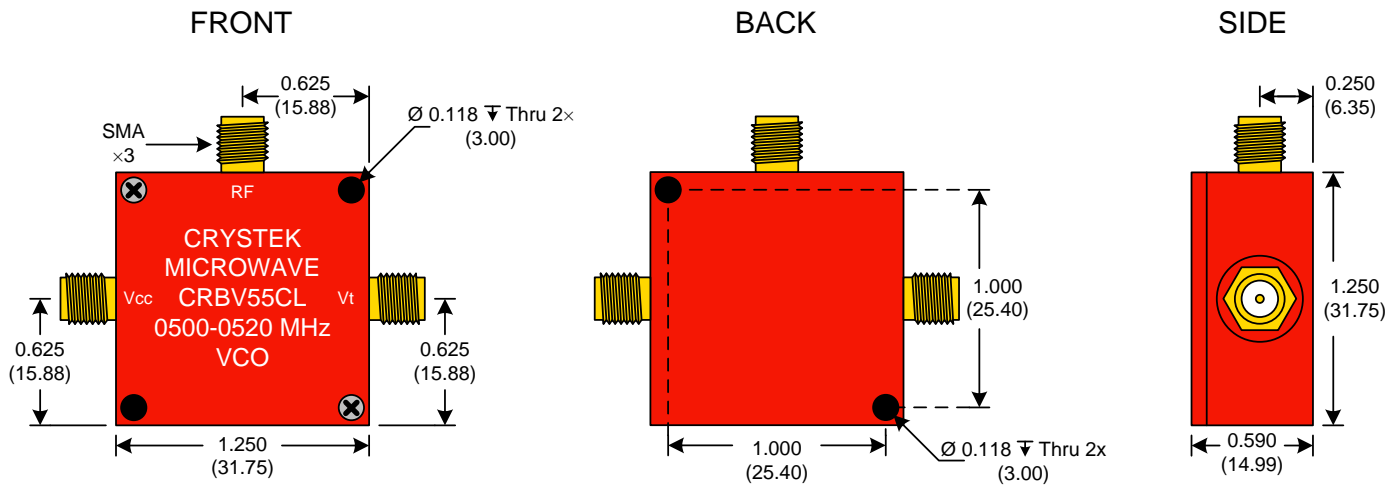

PERFORMANCE SPECIFICATION	MIN	TYP	MAX	UNITS
Lower Frequency:			500	MHz
Upper Frequency:	520			MHz
Tuning Voltage:	0.3		4.7	VDC
Supply Voltage:	4.75	5.0	5.25	VDC
Output Power:	+2.0	+5.0	+8.0	dBm
Supply Current:		25	40	mA
Harmonic Suppression (2 nd Harmonic):		-15	-10	dBc
Pushing:		0.5	1.0	MHz/V
Pulling, all Phases:		0.5	1.0	MHz pk-pk
Tuning Sensitivity:		8		MHz/V
Phase Noise @ 10kHz offset:		-117	-114	dBc/Hz
Phase Noise @ 100kHz offset:		-139	-136	dBc/Hz
Load Impedance:		50		Ω
Input Capacitance:			520	pF
Operating Temperature Range:	-40		+85	$^{\circ}\text{C}$
Storage Temperature Range:	-45		+90	$^{\circ}\text{C}$



● Unless otherwise specified, Dimensions are in: $\frac{\text{IN}}{\text{(mm)}}$

Product Control:

Crystek Part Number:	CRBV55CL-0500-0520	Release Date:	16-Oct-08
Revision Level:	A	Responsible:	C. Vales





Phase Noise (1 Hz BW, Typical)

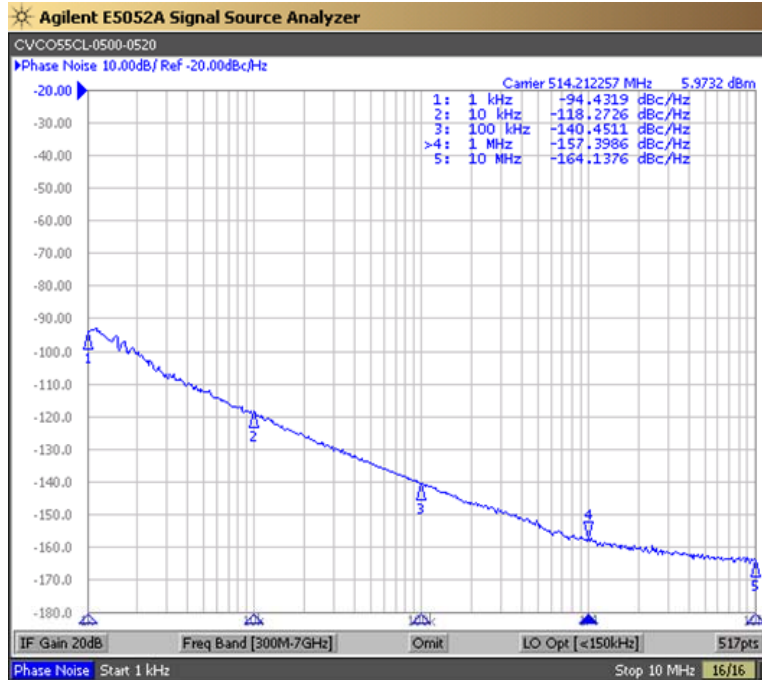

Tuning Curve (Typical)

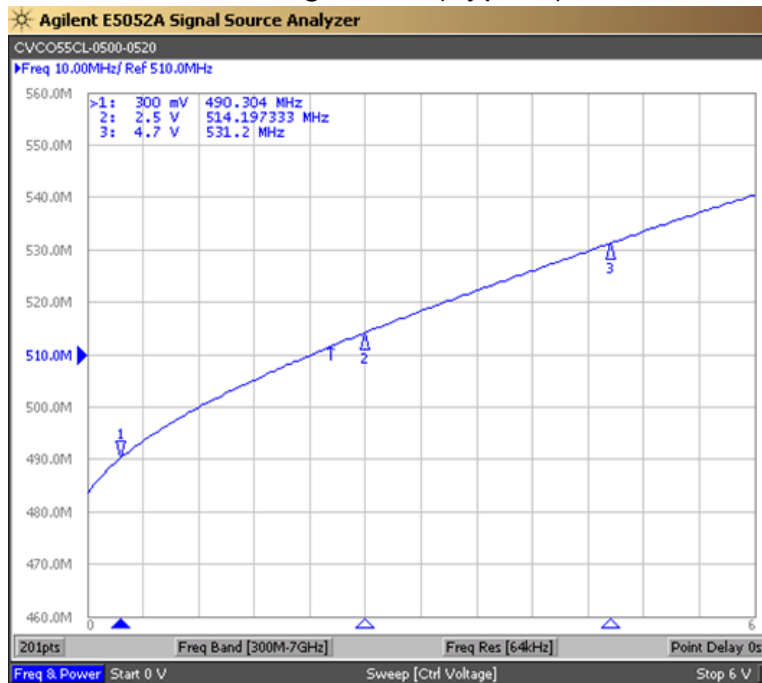

Product Control:

Crystek Part Number:	CRBV55CL-0500-0520	Release Date:	16-Oct-08
Revision Level:	A	Responsible:	C. Vales

Specification is subject to change without notice

