

PERFORMANCE SPECIFICATION	MIN	TYP	MAX	UNITS
Lower Frequency:			2475	MHz
Upper Frequency:	2900			MHz
Tuning Voltage:	0		16.0	VDC
Supply Voltage:	7.6	8.0	8.4	VDC
Output Power:	-5.0	-2.5	0	dBm
Supply Current:		28		mA
Harmonic Suppression (2 nd Harmonic):		-15	-8	dBc
Pushing:		0.5	1.5	MHz/V
Pulling, all Phases:		1.0		MHz pk-pk
Tuning Sensitivity:		30		MHz/V
Phase Noise @ 10kHz offset:		-100	-93	dBc/Hz
Phase Noise @ 100kHz offset:		-120	-113	dBc/Hz
Load Impedance:		50		Ω
Input Capacitance:			47	pF
Operating Temperature Range:	-40		+85	$^{\circ}$ C
Storage Temperature Range:	-45		+90	$^{\circ}$ C

Phase Noise (1 Hz BW, Typical)

Tuning Curve (Typical)

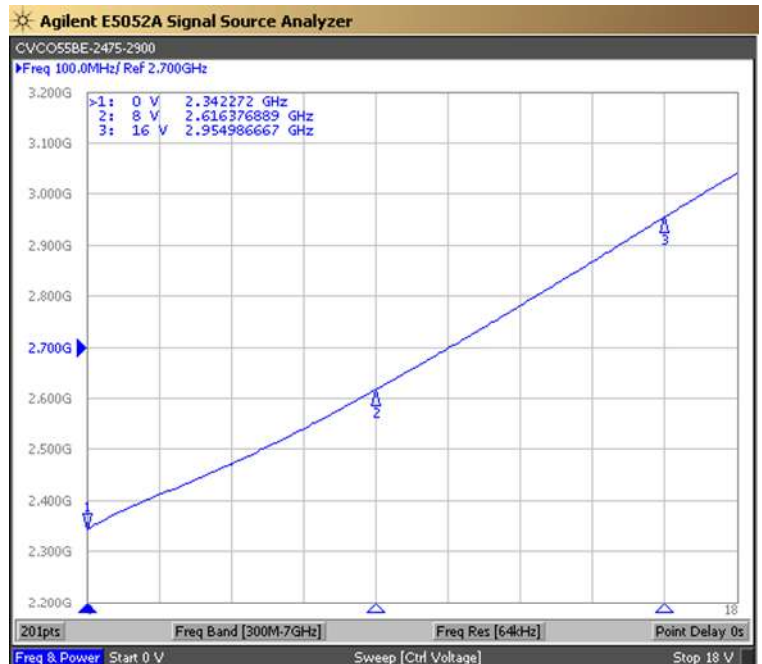
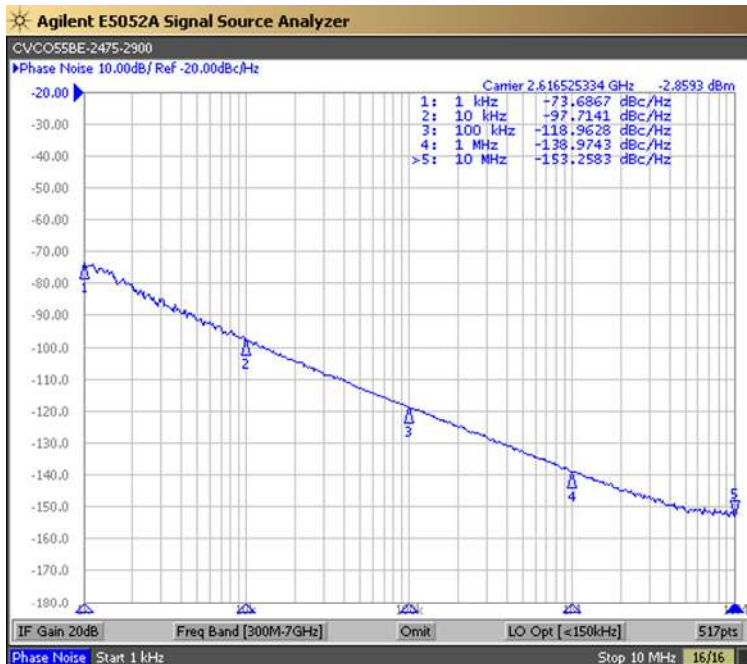

Product Control:

Crystek Part Number:	CVCO55BE-2475-2900	Release Date:	14-Aug-2025
Revision Level:	F	Responsible:	C. Vales

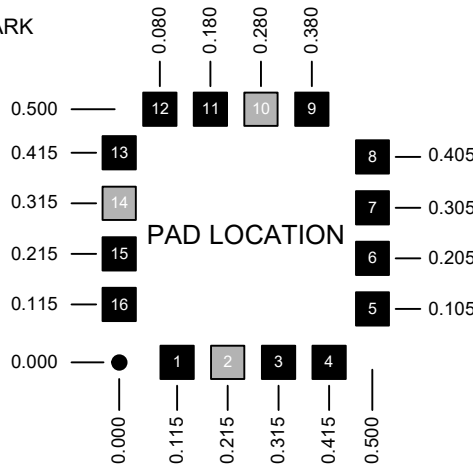
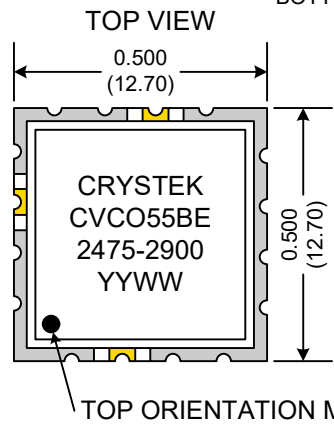
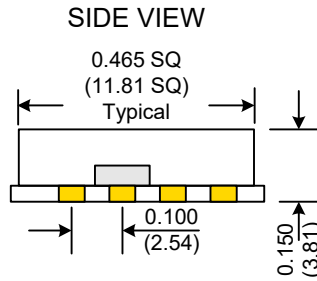
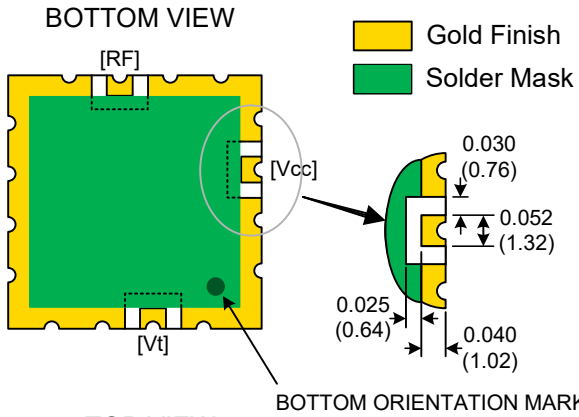

Pad	Connection
2	Vt
10	RF-OUTPUT
14	Vcc
Others	GROUND

- Unless otherwise specified, Dimensions are in: $\frac{IN}{(mm)}$
- Pad Location Dimensions are in: Inches

TAPE AND REEL

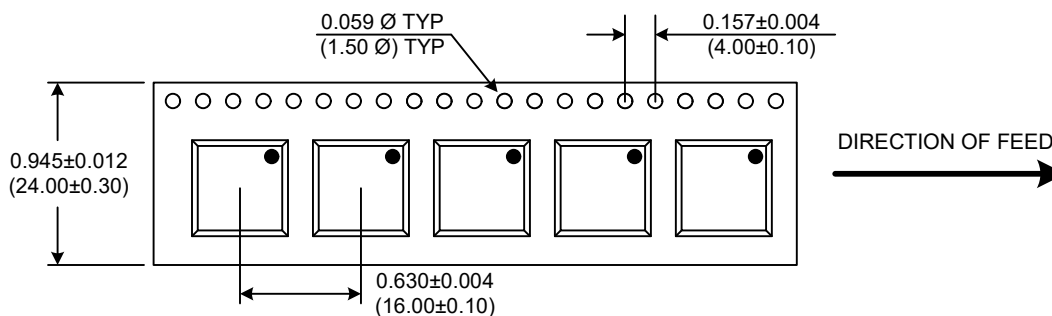

Drawing not to scale

Product Control:

Crystek Part Number:	CVCO55BE-2475-2900	Release Date:	14-Aug-2025
Revision Level:	F	Responsible:	C. Vales

Crystek Corporation reserves the right to make changes to its products and/or information contained herein without notice. No liability is assumed as a result of its use or application.