

CCHD-57518

Ultra-Low Phase Noise Oscillator

CCHD-57518 Model
5×7.5 mm SMD, 1.8V, HCMOS

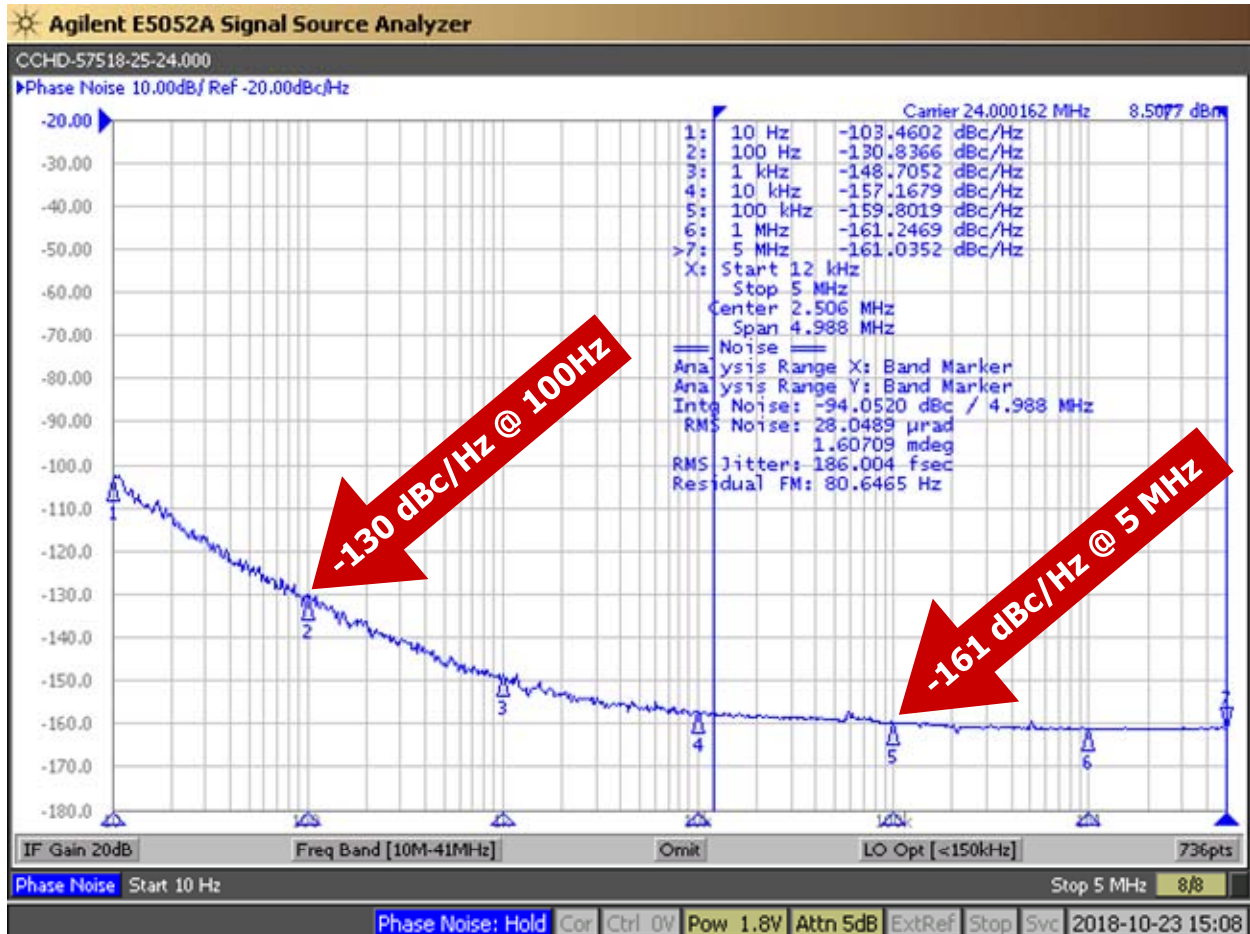
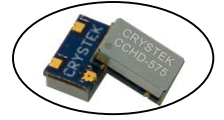

Model CCHD-57518 is the industry's lowest jitter clock oscillator in a 5×7.5 mm package at 1.8V. It features a typical phase jitter of 186 fSec RMS at 24 MHz. Close-in phase noise is -100 dBc/Hz @ 10 Hz while its floor is at -161 dBc/Hz. This oscillator may be small in size but it packs a punch inside. Its output driver is capable of driving ±24mA. This translates to a rise/fall time of ~1ns at 24 MHz with a 15pF load.

Applications include
DACs
ADCs
Low Phase Signal Sources
Test and Measurement

Rev: A
Date: 15-Nov-2018
Page 1 of 2

CCHD-57518

Ultra-Low Phase Noise Oscillator



CCHD-57518 Model
5x7.5 mm SMD, 1.8V, HCMOS

Frequency Range:	20 MHz to 50 MHz
Temperature Range:	0°C to +70°C
	-20°C to +70°C (Option M)
	-40°C to +85°C (Option X)
Storage:	-45°C to 90°C
Input Voltage:	1.8V ±5%
Input Current:	10mA Typical, 15mA Max
Output:	HCMOS
	45/55% Max @ 50% Vdd
Symmetry:	45/55% Max @ 50% Vdd
Rise/Fall Time:	2ns Max @ 20% to 80% Vdd
Logic:	“0” = 10% Vdd Max
	“1” = 90% Vdd Min
Load:	15pF
	Output Current: ±24mA Max
	186 fs RMS Typical @ 24 MHz
	See plot
	-161 dBc/Hz Typical
	None
	<3ppm 1st year, <1ppm thereafter



CCHD-57518 Options:

Temperature Range:	0°C to +70°C (±20ppm, ±25ppm, ±50ppm)
	-20°C to +70°C (±25ppm, ±50ppm)
	-40°C to +85°C (±25ppm, ±50ppm)

Part Number Example:
CCHD-57518X-25-24.000 = 1.8V, 45/55, -40°C to +85°C (±25ppm), 24 MHz

RECOMMENDED REFLOW SOLDERING PROFILE

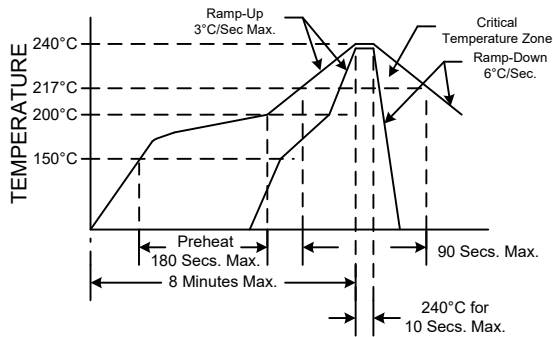

Pad	Connection
1	NC
2	GND
3	Output
4	Vdd

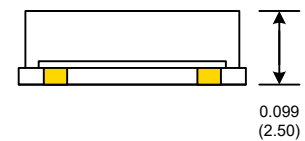
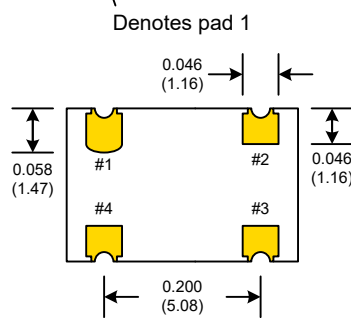
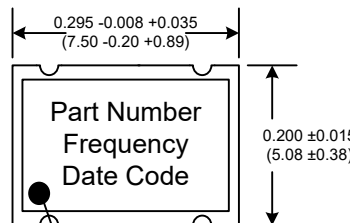

SUGGESTED PAD LAYOUT

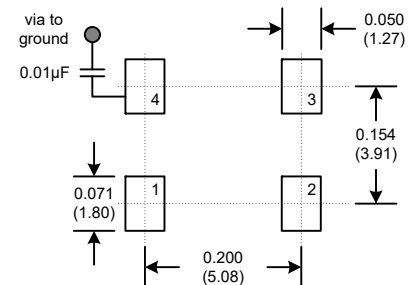

PAD FINISH: Immersion Gold (ENIG); 5 micro inches maximum

Rev: A
Date: 15-Nov-2018
Page 2 of 2