

# CVHD-575

## Ultra-Low Phase Noise

### VCXO

**CVHD-575 Model**  
5×7.5 mm SMD, 3.3V, HCMOS

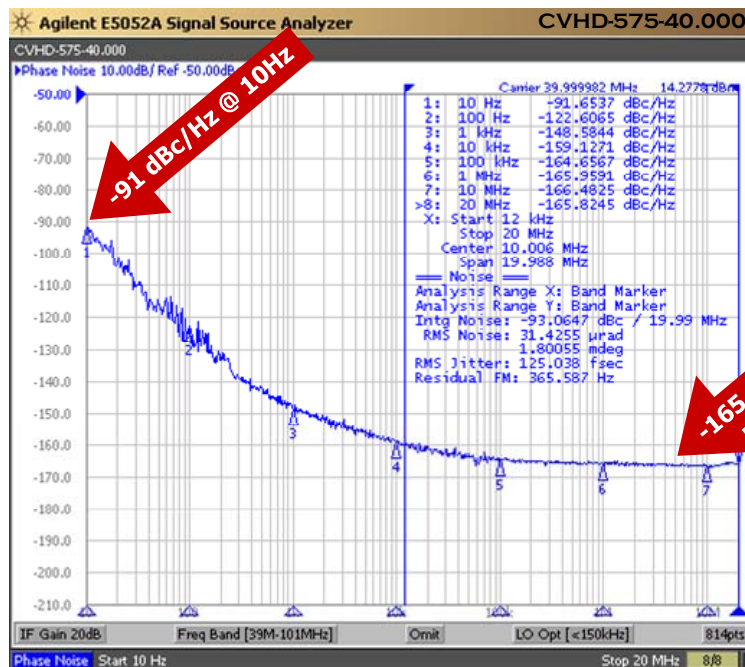
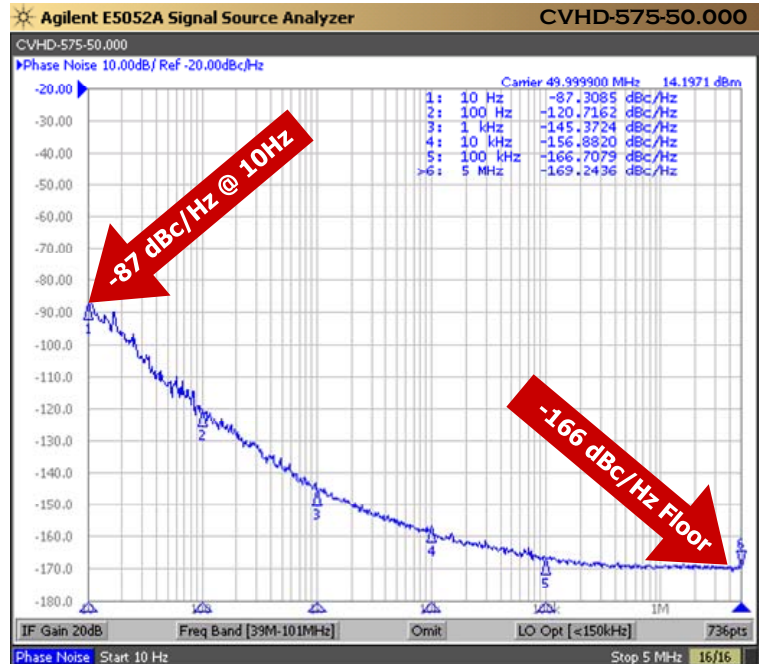
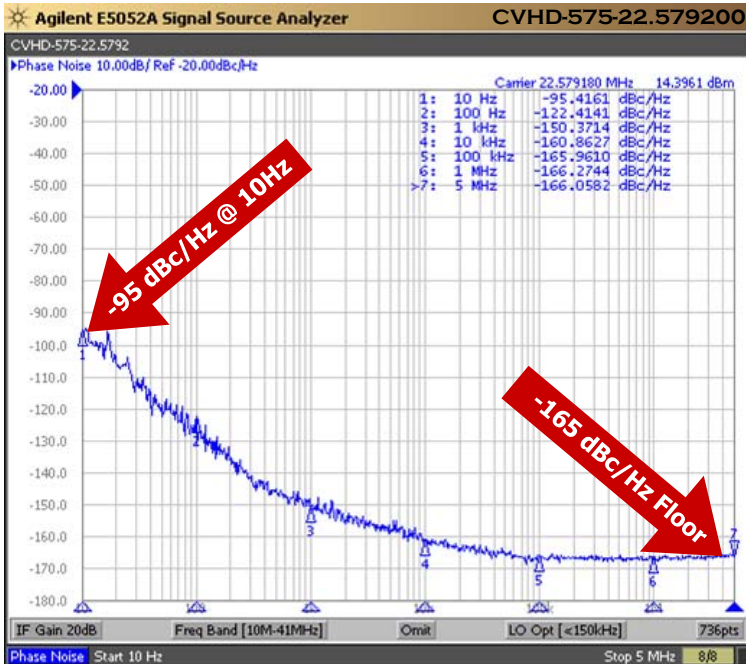

Model CVHD-575 is the industry's lowest phase noise VCXO in a 5×7.5 mm package. Close-in phase noise is -90 dBc/Hz @ 10 Hz while its floor is at -165 dBc/Hz. This oscillator may be small in size but it packs a punch inside. Its output driver is capable of driving ±24mA.

Applications include  
Digital Video, DACs, ADCs for HD Audio,  
Low Phase Signal Sources, Test and Measurement

Rev: J  
Date: 29-Jun-2022  
Page 1 of 3

# CVHD-575

## Ultra-Low Phase Noise

### VCXO



**CVHD-575 Model**  
5×7.5 mm SMD, 3.3V, HCMOS

<b>Frequency Range:</b>	<b>20 MHz to 54.240 MHz*</b>
<b>Temperature Range:</b>	<b>0°C to +70°C (standard)</b>
<b>(Option M)</b>	<b>-20°C to +70°C</b>
<b>(Option X)</b>	<b>-40°C to +85°C</b>
<b>Storage:</b>	<b>-45°C to 90°C</b>
<b>Input Voltage:</b>	<b>3.3V ±0.3V</b>
<b>Input Current:</b>	<b>15mA Typical, 25mA Max</b>
<b>Output:</b>	<b>HCMOS</b>
<b>Symmetry:</b>	<b>45/55% Max @ zero crossing point</b>
<b>Rise/Fall Time:</b>	<b>2ns Max @ 20% to 80% Vdd</b>
<b>Logic:</b>	<b>"0" = 10% Vdd Max</b>
	<b>"1" = 90% Vdd Min</b>
<b>Load:</b>	<b>15pF</b>
<b>Output Current:</b>	<b>±24mA Max</b>
<b>Input:</b>	
<b>Modulation Bandwidth:</b>	<b>&gt;10kHz @ -3dB</b>
<b>Input Impedance:</b>	<b>51 kΩ</b>
<b>Control Voltage:</b>	<b>1.65V ±1.65V</b>
<b>Tuning Sensitivity:</b>	<b>+22ppm/V Typical</b>
<b>Frequency Pulling:</b>	<b>±20ppm APR Min</b>
	<b>(Inclusive of frequency stability, calibration, and aging.)</b>
<b>Linearity:</b>	<b>±10% Max</b>
<b>Phase Jitter: (12kHz~20MHz)</b>	<b>125fs Typical @ 40 MHz</b>
<b>Phase Noise Typical:</b>	<b>See plot</b>
<b>Phase Noise Floor:</b>	<b>-165 dBc/Hz Typical, -162 dBc/Hz Max</b>
<b>Sub-harmonics:</b>	<b>None</b>
<b>Aging:</b>	<b>&lt;3ppm 1<sup>st</sup> year, &lt;1ppm thereafter</b>



**Part Number Example:**  
CVHD-575X-50.000 = 3.3V, 45/55, -40°C to +85°C, 50 MHz

\*Standard Frequencies (MHz)

22.579200	49.152
24.576	50.000
27.000	54.000
40.000	54.240
45.158400	

Absolute Maximum Ratings		
Parameter	Rating	Unit
Input Supply Voltage	+6.0	V
Input Control Voltage	+10.0	V

Rev: J  
Date: 29-Jun-2022  
Page 2 of 3

# CVHD-575

## Ultra-Low Phase Noise

### VCXO



**CVHD-575 Model**  
5×7.5 mm SMD, 3.3V, HCMOS

#### RECOMMENDED REFLOW SOLDERING PROFILE

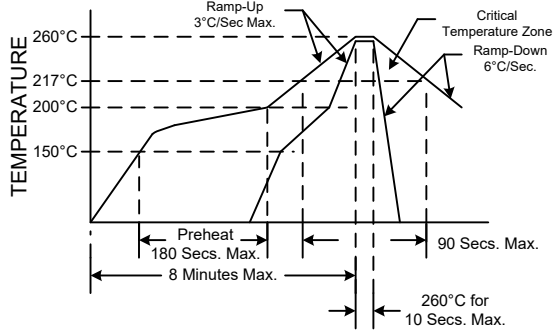

NOTE: Reflow Profile with 240°C peak also acceptable.

Pad	Connection
1	Vc
2	GND
3	Output
4	Vdd

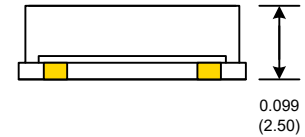
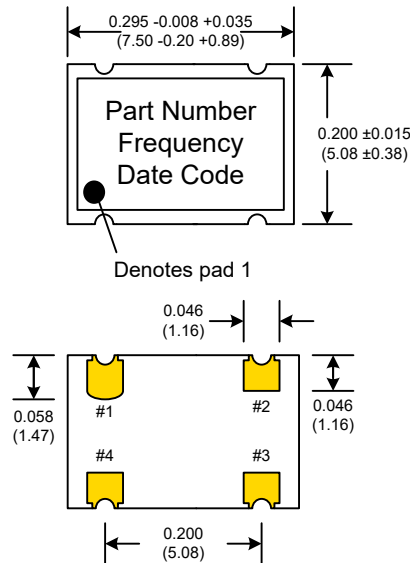

#### SUGGESTED PAD LAYOUT

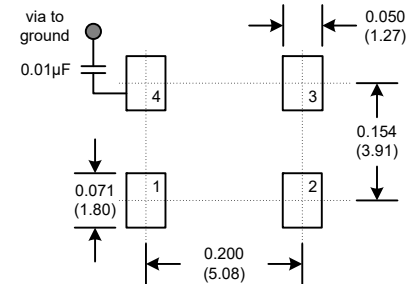

**PAD FINISH:** Immersion Gold (ENIG); 5 micro inches maximum



#### Mechanical:

Shock: MIL-STD-883, Method 2002, Condition B  
Solderability: MIL-STD-883, Method 2003  
Vibration: MIL-STD-883, Method 2007, Condition A  
Solvent Resistance: MIL-STD-202, Method 215  
Resistance to Soldering Heat: MIL-STD-202, Method 210, Condition I or J

#### Environmental:

Thermal Shock: MIL-STD-883, Method 1011, Condition A  
Moisture Resistance: MIL-STD-883, Method 1004

Rev: J  
Date: 29-Jun-2022  
Page 3 of 3